

Job Name/Location:

Tag #:

Date:

For: File Resubmit

PO No.:

Approval Other _____

Architect:

GC:

Engr:

Mech:

Rep:

(Company)

(Project Manager)

ARNU093B3G4
Multi V™ Ducted (Low Static Built-In)
9,600 Btu/h Indoor Unit



shown with optional grill and canvas accessories

Performance:

Total Cooling Capacity (Btu/h)	9,600
Heating Capacity (Btu/h)	10,900
Power Input ¹ (W)	85

Cooling Nominal Test Conditions:

Indoor: 80°F DB/67°F WB

Outdoor: 95°F DB

Heating Nominal Test Conditions:

Indoor: 70°F DB

Outdoor: 47°F DB/43°F WB

Electrical:

Power Supply (V/Hz/∅)	208-230/60/1
Rated Amps (A)	0.76

Piping:

Refrigerant:

Liquid Line (in, OD)	1/4 Flare
Vapor Line (in, OD)	1/2 Flare

Condensate:

Condensate Pump Drain ² (in,OD)	1
--	---

Controls Features:

- Auto changeover (Heat Recovery only)
- Auto operation
- Auto restart
- Child lock
- Dual thermistor control
- Hot start
- Self diagnostics
- Timer (on/off)
- Weekly schedule
- Fan speed control
- Dual setpoint control
- Multiple aux heater applications
- Filter life and power consumption display

Optional Accessories:

- Wireless Remote Controller - PQWRHQ0FDB
- LG Programmable Controller - PREMTB10U
- LG Premium Controller - PREMTA000
- Simple Controller with Mode (Black) - PQRCVCLQO
- Simple Controller with Mode (White) - PQRCVCLQW
- Simple Controller without Mode (Black) - PQRCHCAOQ
- Simple Controller without Mode (White) - PQRCHCAQW
- Simple Dry Contact (1 contact, 24 VAC external power) - PQDSB1
- Dry Contact for Economizer - PQDSBC1
- Dry Contact for Third Party Thermostat - PQDSBNGCM1
- Wall Mounted Temperature Sensor - PQRSTAO
- Return Air Grille - PBSGB30 (Includes washable filter)
- Return Air Canvas - PBSC30

Entering Mixed Air:

Cooling Max ⁴ (°F WB)	76
Heating Min (°F DB)	59

Unit Data:

Refrigerant Type	R410A
Refrigerant Control	EEV
Sound Pressure ⁵ dB(A) (H/M/L)	34 / 33 / 32
Filter Type	Washable
Filter Quantity	1
Filter Dimensions	29-5/8" x 6-5/8" x 1/4"
Net Unit Weight (lbs)	46
Shipping Weight (lbs)	53

Fan:

Type	Sirocco
Fan Quantity	3
Motor/Drive	Brushless Digitally Controlled/Direct
Motor Quantity	2
High Mode Airflow Rate H/M/L (CFM)	318 / 247 / 212
High Mode External Static Pressure (ESP) ⁶ (in wg)	0.08
Standard Mode Airflow Rate H/M/L (CFM)	318 / 247 / 212
Standard Mode External Static Pressure ⁶ (in wg)	0
Minimum ESP ⁷	0
Maximum ESP ⁷	0.15

Notes:

- 1.The Power Input is rated at high speed.
- 2.Maximum lift is 27 inches from bottom of unit. Check valve not included (field supplied).
- 3.Requires an LG Programmable Thermostat, Simple Controller with Mode or a Simple Controller without Mode.
- 4.See Engineering Manual for sensible and latent capacities.
- 5.Sound Pressure levels are tested in an anechoic chamber under ISO Standard 3745.
- 6.At factory fan speed setting.
- 7.Maximum static pressure may result in reduced airflow (CFM).
- 8.All communication cable to be minimum 18 AWG, 2-conductor, stranded, shielded and must comply with applicable local and national code.
- 9.Power wiring cable size must comply with the applicable local and national code.
- 10.This unit comes with a dry nitrogen charge.
- 11.This data is rated 0 ft above sea level, with 25 ft of refrigerant line per indoor unit and a 0 ft level difference between outdoor and indoor units. All capacities are net with a combination ratio between 95 – 105%.
- 12.Must follow installation instructions in the applicable LG installation manual.



ARNU093B3G4

Multi V™ Ducted (Low Static Built-In)
9,600 Btu/h Indoor Unit



Tag #:

Date:

PO No.:

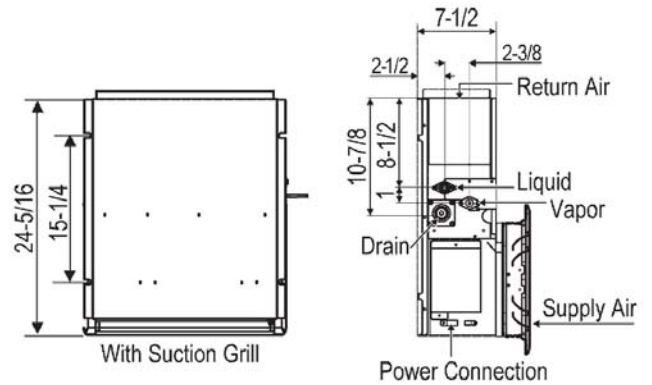
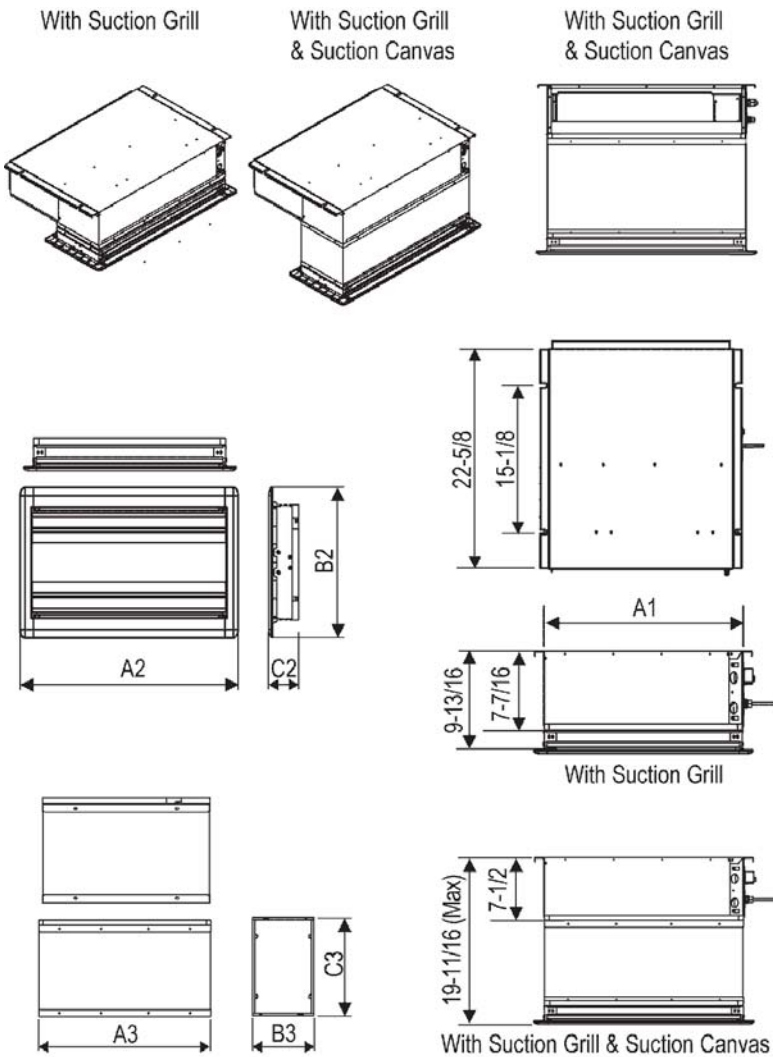

Model	A1
ARNU073B3G4	
ARNU093B3G4	32-5/8
ARNU123B3G4	
ARNU153B3G4	
ARNU183B4G4	43-5/16
ARNU243B4G4	

Unit: inches
Note: All measurements have a tolerance of ±1/4 in.

Accessory	A2	B2	C2
PBSGB30	35-13/16	14-1/8	2-3/16
PBSGB40	46-13/16	14-1/8	2-3/16

Accessory	A3	B3	C3
PBSC30	32-5/16	10-11/16	1-9/16 to 9-13/16
PBSC40	43-5/16	10-11/16	1-9/16 to 9-13/16