

Job Name/Location:

Tag #:

Date: _____ For: File Resubmit
 PO No.: _____ Approval Other _____
 Architect: _____ GC: _____
 Engr: _____ Mech: _____
 Rep: _____
 (Company) _____ (Project Manager) _____



LS307HV3
Standard Single Zone Inverter
 Outdoor Unit (ODU)-LSU307HV3 Indoor Unit (IDU)-LSN307HV3



Performance:

Cooling:

Capacity (Min-Rated-Max, Btu/h)	3,070-30,000-34,000
SEER	18.0
EER	10.0

SEER - Seasonal Energy Efficiency Ratio EER - Energy Efficiency Ratio

Heating:

Capacity (Min-Rated-Max, Btu/h)	3,070-32,000-38,900
HSPF	9.5

HSPF - Heating Seasonal Performance Factor

Cooling Nominal Test Conditions: Indoor: 80°F DB/67°F WB Outdoor: 95°F DB/75°F W
 Heating Nominal Test Conditions: Indoor: 70°F DB/60°F WB Outdoor: 47°F DB/43°F WB

Electrical:

Power Supply (V ¹ /Hz/Ø)	208-230/60/1
-------------------------------------	--------------

Outdoor Unit:

MOP (A)	25
MCA (A)	19
Cooling Rated Amps (A)	15.4
Heating Rated Amps (A)	15.4
Compressor (A)	14.6
Fan Motor (A)	0.25

MOP - Maximum Overcurrent Protection MCA - Minimum Circuit Ampacity

Total Power Input:

Cooling Power Input (kW)	3.0
Heating Power Input (kW)	3.1

Piping:

Liquid Line (in, OD)	3/8
Vapor Line (in, OD)	5/8
Additional Refrigerant (oz/ft)	0.38
Max Pipe Length (ft) ²	98.4
Piping Length (no add'l refrigerant, ft)	24.6
Max Elevation (ft)	49.2

Controls Features:

- 24-Hour on/off timer
- Auto changeover
- Auto restart
- Auto sleep mode
- Built-in low ambient standard, down to 14°F (cooling mode)
- Chaos swing
- Condensate Sensor Connection
- Defrost control
- Energy saving
- Evaporator frost control
- Inverter (variable speed compressor)
- Jet cool/Jet heat
- Manual power switch
- 3M HAF Filter
- Self-cleaning indoor coil
- Temperature display on indoor unit
- Cooling only function

Optional Accessories:

- LG Programmable Thermostat - PREMTB10U
- Dry Contact for third party thermostat - PQDSBNGCM1
- Low Ambient Wind Baffle (Cooling operation to 0°F) - ZLABGP02A
- PI-485 - PMNFP14A1

Operating Range:

Outdoor Unit:

Cooling (°F DB)	14-118
Heating (°F WB)	-4-65

Indoor Unit:

Cooling (°F WB)	53-75
Heating (°F DB)	60-86

Unit Data:

Refrigerant Type	R410A
Refrigerant Control	EEV
Refrigerant Charge (lbs)	4.41
ODU Sound Pressure Max (±3 dB(A)) ³	55
IDU Sound Pressure (H/M/L) (±3 dB(A)) ³	49/44/39
ODU Net Weight (lbs)	128
ODU Shipping Weight (lbs)	137
IDU Net Weight (lbs)	36
IDU Shipping Weight (lbs)	42
Heat Exchanger Coating	GoldFin™

Fan:

ODU Type	Propeller
IDU Type	Cross Flow
Fan Speeds (Fan/Cooling/Heating)	4/4/4
Quantity (ODU + IDU)	1 + 1
Motor/Drive	Brushless Digitally Controlled/Direct
ODU Max Air Flow Rate (CFM)	2,119
IDU Air Flow H/M/L (CFM)	770/629/424
Dehumidification (pts/hr)	10.6

Notes:

1. Acceptable operating voltage: 187V - 253V.
2. Piping lengths are equivalent.
3. Sound Pressure levels are tested in an anechoic chamber under ISO Standard 1996.
4. All communication/power cable to be minimum 18 AWG, 4-conductor, stranded, shielded and must comply with applicable local and national code.
5. See Engineering Manual for sensible and latent capacities.
6. Power wiring cable size must comply with the applicable local and national code.
7. The indoor unit comes with a dry helium charge.
8. This data is rated 0 ft above sea level, with 24.6 ft of refrigerant line and a 0 ft level difference between outdoor and indoor units.
9. Must follow installation instructions in the applicable LG installation manual.



Outdoor Unit (ODU)-LSU307HV3

Standard Single Zone Inverter



Tag #:

Date:

PO No.:

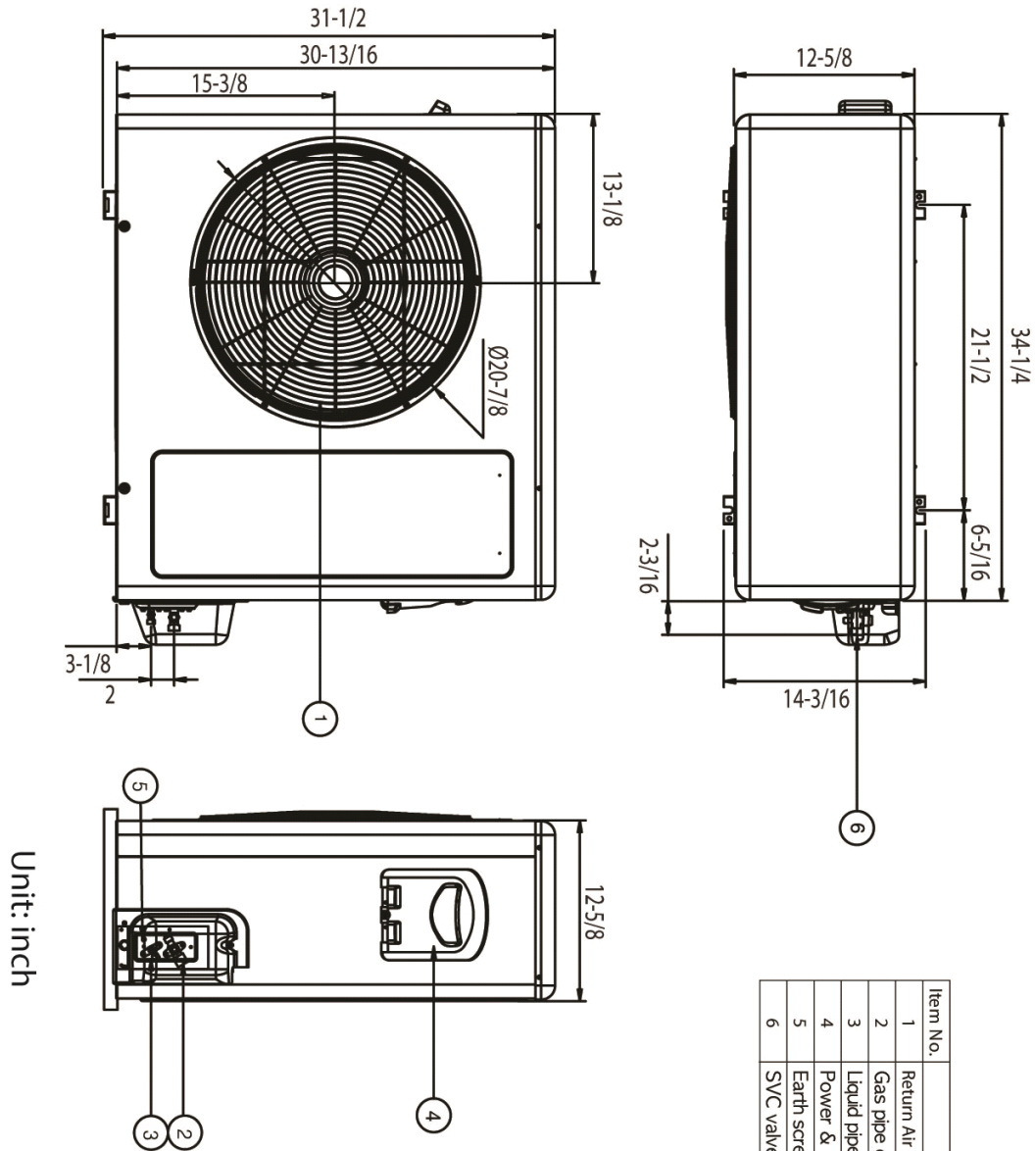

Unit: inch

Item No.	Part Name	Remarks
1	Return Air Grille	
2	Gas pipe connection	
3	Liquid pipe connection	
4	Power & Transmission connection	
5	Earth screw	
6	SVC valve cover	

Indoor Unit (IDU)-LSN307HV3
Standard Single Zone Inverter



Tag #: _____
Date: _____
PO No.: _____

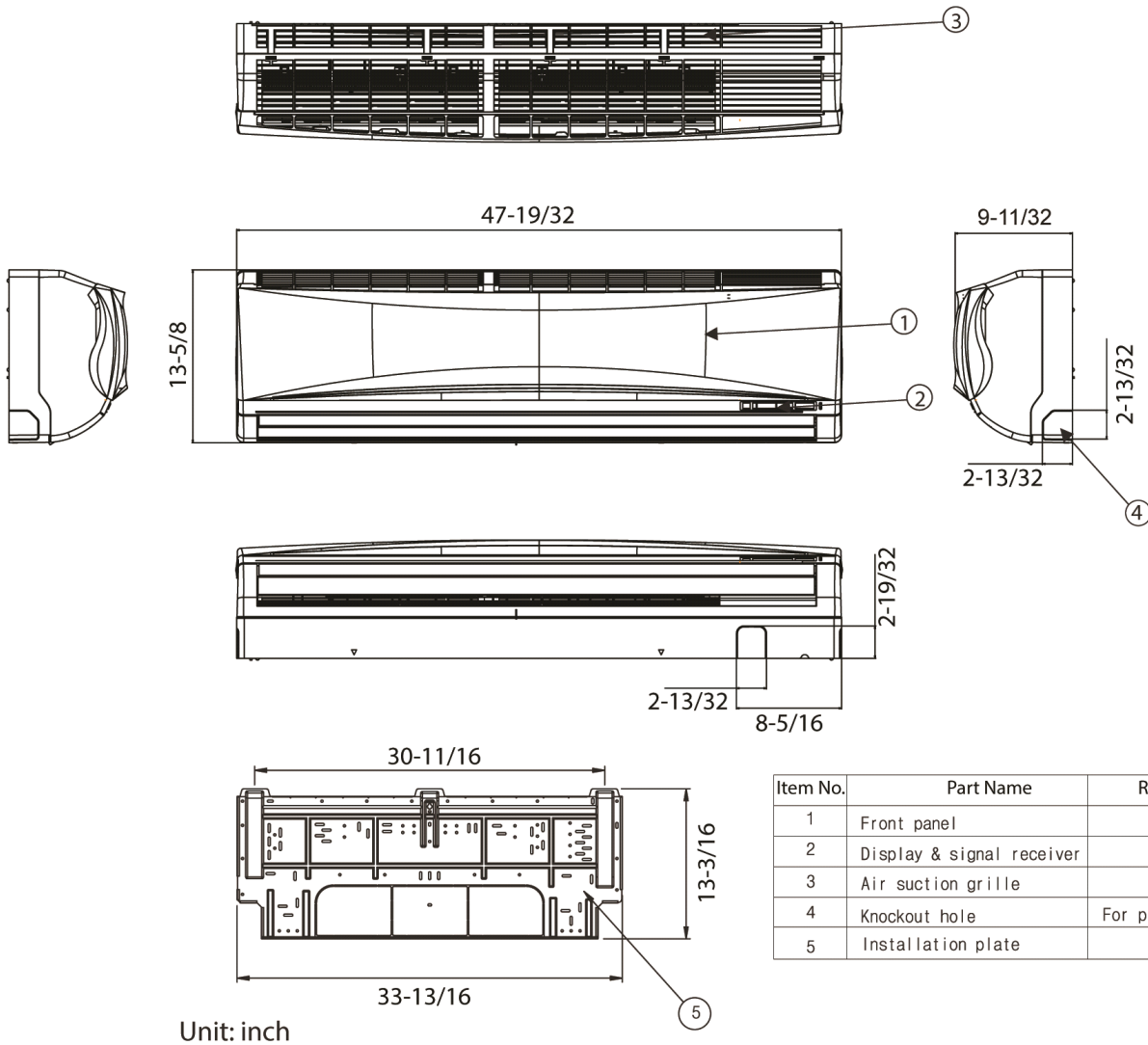

Item No.	Part Name	Remarks
1	Front panel	
2	Display & signal receiver	
3	Air suction grille	
4	Knockout hole	For pipe and cable
5	Installation plate	

Unit: inch