

Date: _____

For: File Resubmit
 Approval Other _____

PO No.: _____

Architect: _____

GC: _____

Engr: _____

Mech: _____

Rep: _____

(Company)

(Project Manager)



ARNU283TMAA
 Multi V™ 4-Way Ceiling Cassette
 28,000 Btu/h Indoor Unit

Performance:

Total Cooling Capacity (Btu/h)	28,000
Heating Capacity (Btu/h)	31,500
Power Input ¹ (W)	65

Cooling Nominal Test Conditions: Heating Nominal Test Conditions:
 Indoor: 80°F DB/67°F WB Indoor: 70°F DB
 Outdoor: 95°F DB Outdoor: 47°F DB/43°F WB

Electrical:

Power Supply (V/Hz/∅)	208-230/60/1
Rated Amps (A)	0.56

Piping:

Refrigerant:

Liquid Line (in, OD)	3/8 Flare
Vapor Line (in, OD)	5/8 Flare

Condensate:

Condensate Line (in, OD)	1
Factory Installed Pump ²	Yes

Controls Features:

- Auto changeover (Heat Recovery Only)
- Auto operation
- Auto restart
- Child lock
- Dual thermistor control
- Forced operation
- Group control
- High ceiling
- Hot start
- Self diagnostics
- Sleep mode
- Timer (on/off)
- Weekly schedule
- Soft dry (dehumidification)
- Auto direction/swing (up/down)
- Fan speed control
- Chaos wind (random fan speed)
- Swirl wind (alternating vanes)
- Jet cool (fast cooling)

Required Accessories:

- Grille Kit (PT-UMC1)

Optional Accessories:

- Wireless Handheld Remote Controller - PQWRHDF0
- LG Programmable Thermostat - PREMTB10U
- Simple Controller with Mode (Black) - PQRVCVCL0Q
- Simple Controller with Mode (White) - PQRVCVCL0QW
- Simple Controller without Mode (Black) PQRCHCA0Q
- Simple Controller without Mode (White) - PQRCHCA0QW
- Dry Contact Unit (1 contact, 24 VAC external power) - PQDSB1
- Dry Contact with Economizer Interface- PQDSBC1
- Dry Contact for Third Party Thermostat - PQDSBNGCM1
- Wall Mounted Temperature Sensor - PQRSTA0
- Ventilation Kit - PTVK410 + PTVK420
- Auto Elevation Kit - PTEGM0
- Plasma Kit - PTPKMO

Entering Mixed Air:

Cooling Max ³ (°F WB)	76
Heating Min (°F DB)	59

Unit Data:

Refrigerant Type	R410A
Refrigerant Control	EEV
Sound Pressure ⁴ dB(A) (H/M/L)	39/36/32
Primary Filter Type	Washable
Secondary Filter Type	Not included
Net Weight (lbs)	61
Shipping Weight (lbs)	73
Grille Weight (lbs)	13
Grille Shipping Weight (lbs)	20

Fan:

Type	Turbo
Quantity	1
Motor/Drive	Brushless Digitally Controlled/Direct
Motor Quantity	1
Airflow Rate H/M/L (CFM)	812/742/636

Notes:

- 1.The Power Input is rated at high speed.
- 2.Maximum lift is 27 in from bottom of unit.
- 3.See Engineering Manual for sensible and latent capacities.
- 4.Sound Pressure levels are tested in an anechoic chamber under ISO Standard 3745.
- 5.All communication cable to be minimum 18 AWG, 2-conductor, stranded, shielded and must comply with applicable local and national code.
- 6.Power wiring cable size must comply with the applicable local and national code.
- 7.This unit comes with a dry nitrogen charge.
- 8.This data is rated 0 ft above sea level, with 25 ft of refrigerant line per indoor unit and a 0 ft level difference between outdoor and indoor units. All capacities are net with a combination ratio between 95 – 105%.
- 9.Must follow installation instructions in the applicable LG installation manual.



Job Name/Location:

ARNU283TMAA

Multi V™ 4-Way Ceiling Cassette
28,000 Btu/h Indoor Unit



Tag #:

Date:

PO No.:

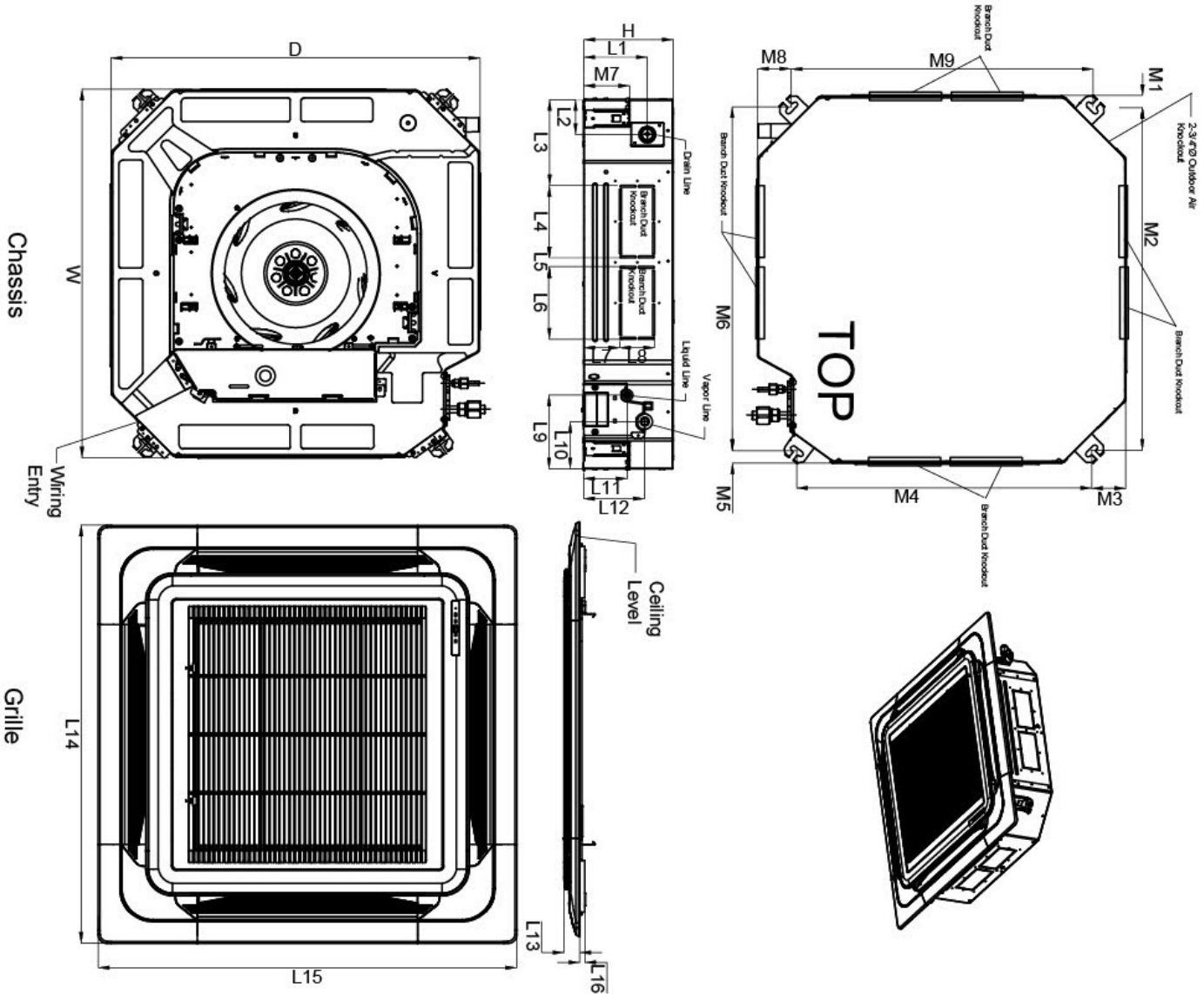

W	33-1/16"
H	11-5/16"
D	33-1/16"
L1	8-9/16"
L2	3-1/8"
L3	7-11/16"
L4	6-1/2"
L5	3/4"
L6	6-1/2"
L7	4-1/16"
L8	3-15/16"
L9	6-5/8"
L10	4-5/16"
L11	4"
L12	5-1/2"
L13	1-7/16"
L14	37-3/8"
L15	37-3/8"
L16	1/2"
M1	1-1/16"
M2	30-15/16"
M3	3-1/16"
M4	26-7/16"
M5	1-1/16"
M6	30-15/16"
M7	4-1/8"
M8	3-1/16"
M9	26-15/16"

Note - All dimensions have a tolerance of ± 0.25 in.