

Job Name/Location:

Tag #:

Date:

For:  File  Resubmit  
 Approval  Other \_\_\_\_\_

PO No.:

Architect: \_\_\_\_\_ GC: \_\_\_\_\_

Engr: \_\_\_\_\_ Mech: \_\_\_\_\_

Rep: \_\_\_\_\_  
 (Company) (Project Manager)



**ARNU093B1G2**  
 Multi V™ Ducted (Low Static)  
 9,600 Btu/h Indoor Unit



**Performance:**

Total Cooling Capacity (Btu/h)	9,600
Heating Capacity (Btu/h)	10,900
Power Input <sup>1</sup> (W)	30

Cooling Nominal Test Conditions: Indoor: 80°F DB/67°F WB  
 Heating Nominal Test Conditions: Indoor: 70°F DB  
 Outdoor: 95°F DB Outdoor: 47°F DB/43°F WB

**Electrical:**

Power Supply (V/Hz/∅)	208-230/60/1
Rated Amps (A)	0.1

**Piping:**

Refrigerant:

Liquid Line (in, OD)	1/4 Flare
Vapor Line (in, OD)	1/2 Flare

Condensate:

Condensate Pump Drain <sup>2</sup> (in,OD)	1 Plain
--	---------

**Controls Features:**

- Auto changeover (Heat Recovery only)
- Auto operation
- Auto restart
- Child lock
- Dual thermistor control
- Hot start
- Self diagnostics
- Sleep mode
- Timer (on/off)
- Weekly schedule
- Soft dry (dehumidification)
- Fan speed control

**Optional Accessories:**

- Wireless Handheld Remote Controller<sup>3</sup> - PQWRHDF0
- LG Programmable Thermostat - PREMTB10U
- Simple Controller with Mode (Black) - PQRVCVLOQ
- Simple Controller with Mode (White) - PQRVCVLOQW
- Simple Controller without Mode (Black) PQRCHCA0Q
- Simple Controller without Mode (White) - PQRCHCA0QW
- Dry Contact Unit (1 contact, 24 VAC external power) - PQDSB1
- Dry Contact with Economizer Interface- PQDSBC1
- Dry Contact for Third Party Thermostat - PQDSBNGCM1
- Wall Mounted Temperature Sensor - PQRSTA0

**Entering Mixed Air:**

Cooling Max <sup>4</sup> (°F WB)	76
Heating Min (°F DB)	59

**Unit Data:**

Refrigerant Type	R410A
Refrigerant Control	EEV
Sound Pressure <sup>5</sup> dB(A) (H/M/L)	34/33/32
Filter Type	Washable
Filter Quantity	1
Filter Dimensions	29-5/8" x 6-5/8" x 1/4"
Net Unit Weight (lbs)	47
Shipping Weight (lbs)	51

**Fan:**

Type	Sirocco
Fan Quantity	3
Motor/Drive	Brushless Digitally Controlled/Direct
Motor Quantity	2
Airflow Rate H/M/L (CFM)	335/300/265
External Static Pressure (ESP) <sup>6</sup> (in wg)	0.08
Minimum ESP/Fan Setting Value <sup>7</sup>	0/78
Maximum ESP/Fan Setting Value <sup>7</sup>	0.15/115

**Notes:**

- 1.The Power Input is rated at high speed.
- 2.Maximum lift is 27 inches from bottom of unit. Check valve not included (field supplied).
- 3.Requires an LG Programmable Thermostat, Simple Controller with Mode or a Simple Controller without Mode.
- 4.See Engineering Manual for sensible and latent capacities.
- 5.Sound Pressure levels are tested in an anechoic chamber under ISO Standard 3745.
- 6.At factory fan speed setting.
- 7.Maximum static pressure may result in reduced airflow (CFM).
- 8.All communication cable to be minimum 18 AWG, 2-conductor, stranded, shielded and must comply with applicable local and national code.
- 9.Power wiring cable size must comply with the applicable local and national code.
- 10.This unit comes with a dry nitrogen charge.
- 11.This data is rated 0 ft above sea level, with 25 ft of refrigerant line per indoor unit and a 0 ft level difference between outdoor and indoor units. All capacities are net with a combination ratio between 95 – 105%.
- 12.Must follow installation instructions in the applicable LG installation manual.



# ARNU093B1G2

Multi V™ Ducted (Low Static)

9,600 Btu/h Indoor Unit



Tag #:

Date:

PO No.:

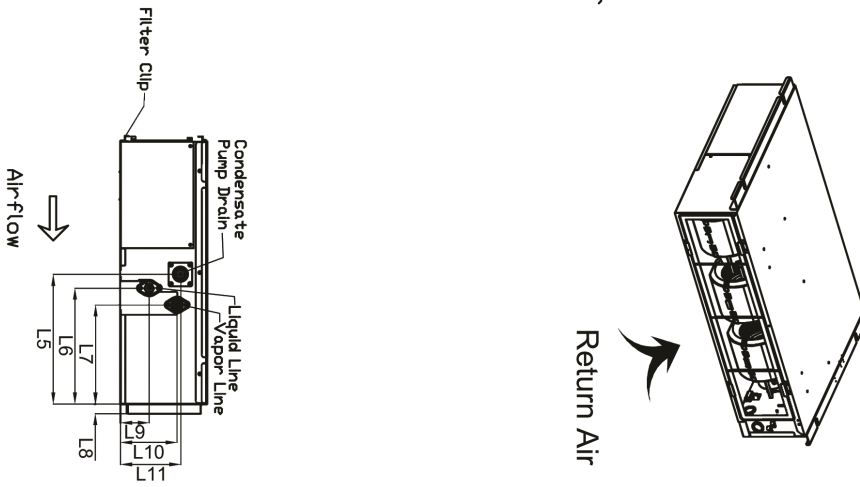
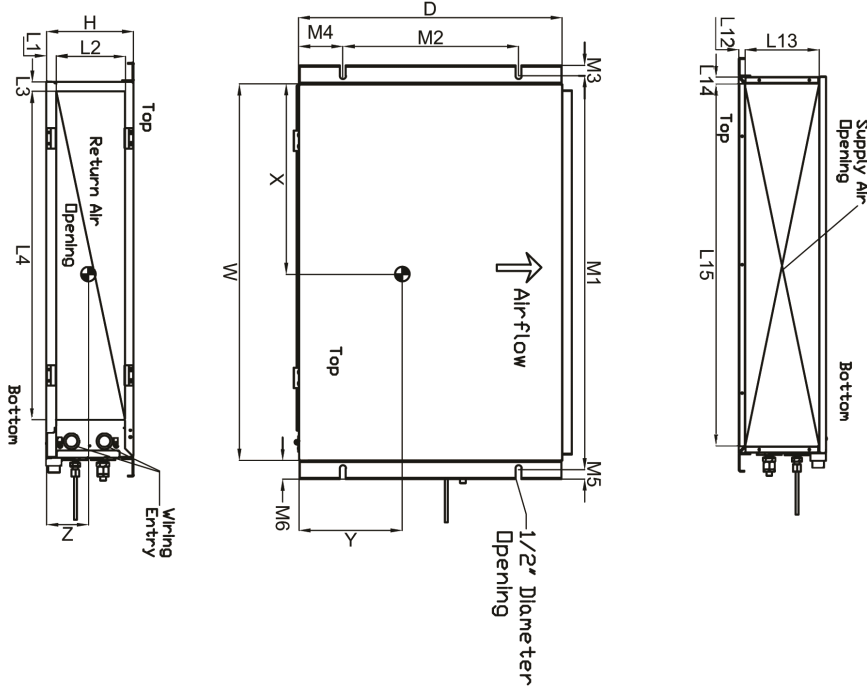

W	32 5/8"
D	22 5/8"
H	7 1/2"
L1	7/8"
L2	6"
L3	7/8"
L4	28 11/16"
L5	11 1/16"
L6	10 1/8"
L7	8 5/8"
L8	13/16"
L9	2 3/4"
L10	5 3/16"
L11	5 3/8"
L12	1/2"
L13	6 1/2"
L14	3/4"
L15	31 3/8"
M1	33 15/16"
M2	15 1/16"
M3	13/16"
M4	3 5/16"
M5	13/16"
M6	1 5/8"

X	16 7/8"
Y	7 5/16"
Z	2 7/8"

All dimensions have a tolerance of ± 0.25 in.