



Visit us at : <http://www.lgservice.com>

LG

LG

PI485 for Outdoor Unit

INSTALLATION MANUAL

**Models: PMNFP14A0
PMNFP14A1
PGNFP14A0**

ENGLISH

ITALIANO

ESPAÑOL

FRANÇAIS

DEUTSCH

CHINESE

IMPORTANT

- Please read this installation manual completely before installing the product.
- Installation work must be performed in accordance with the national wiring standards by authorized personnel only.
- Please retain this installation manual for future reference after reading it thoroughly.

TABLE OF CONTENTS

■ Safety Precautions.....	3~4
■ Part Description	5
■ Accessory Parts	6
■ Installation Guide.....	7~11
■ Installation Steps.....	7
■ DIP Switch Configuration.....	8
■ Simple Central Controller Connection Diagram	9
■ PC / Deluxe Central Controller Connection Diagram	10
■ How to connect the base station controller	11

Safety Precautions



To prevent injury to the user or other people and property damage, the following instructions must be followed.

- Incorrect operation due to ignoring instruction will cause harm or damage. The seriousness is classified by the following indications.

⚠ WARNING This symbol indicates the possibility of death or serious injury.

⚠ CAUTION This symbol indicates the possibility of injury or damage.

- Meanings of symbols used in this manual are as shown below.

	Be sure not to do.
	Be sure to follow the instruction.

⚠ WARNING

■ Installation

Don't touch with the hands while the power is on

- There is risk of fire or electric shock.

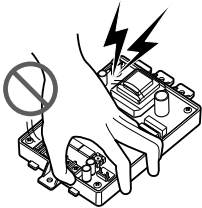

Use standard parts(connector).

- Do not disassemble or repair the product. There is risk of fire or electric shock.

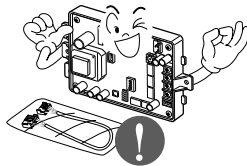

For electrical work, contact the dealer, seller, a qualified electrician, or an Authorized Service Center.

- Do not disassemble or repair the product. There is risk of fire or electric shock.



Use the correctly rated breaker or fuse.

- There is risk of fire or electric shock.

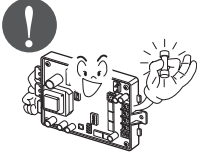

Do not install, remove, or re-install the unit by yourself (customer).

- There is risk of fire, electric shock, explosion, or injury.

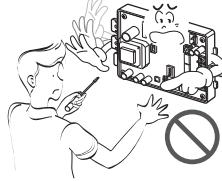

For installation, always contact the dealer or an Authorized Service Center.

- There is risk of fire, electric shock, explosion, or injury.

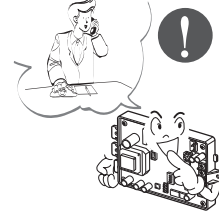

■ Operation

When the product is soaked (flooded or submerged) in water, contact an Authorized Service Center.

- There is risk of fire or electric shock.



Ensure water does not enter the product.

- There is risk of fire, electric shock, or product damage.

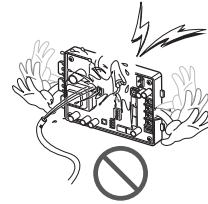

Part Description

PMNFP14A0 / PMNFP14A1 / PGNFP14A0

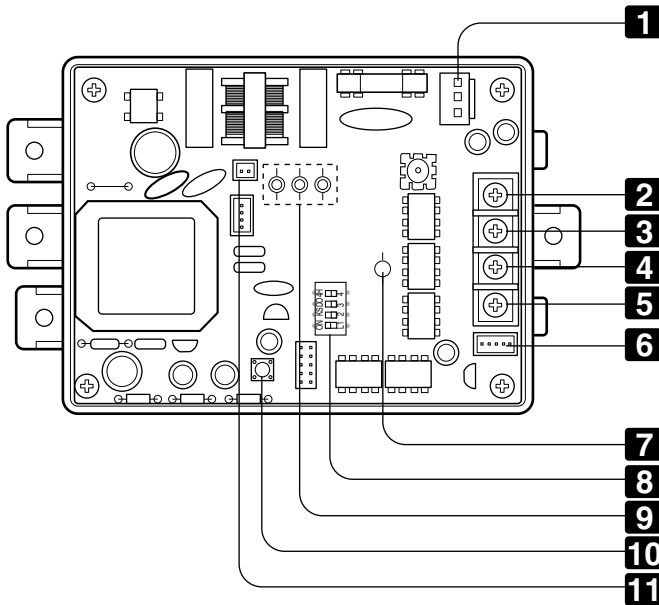

* The location of parts might be different in case of PMNFP14A1.

PMNFP14A0 : For connecting 1 ~ 16 Indoor Units

PMNFP14A1 : For connecting 1 ~ 48 Indoor Units

PGNFP14A0 : For connecting only base controller

PI485 GATEWAY(M)

- 1** CN_PWR: AC 220V Connector
- 2** +10V: DC 10V Terminal
- 3** GND: Ground
- 4** BUS_A: *RS-485 (+) Terminal
(Refer to note)
- 5** BUS_B: RS-485 (-) Terminal
- 6** CN_OUT: Outdoor Unit Connector
- 7** LED1:RS-485 Status LED
- 8** DIP Switch: Product Selection (Refer to the 「DIP Switch Configuration」)
- 9** LED01G, 02G, 03G: Communication Status LED
- 10** Reset Switch: PI485(M) Reset
- 11** CN_DRY: DRY Contact

* **Note** : RS-485 is one of the international interface standards for serial communication.

Accessory Parts

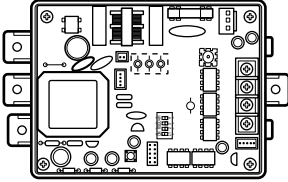
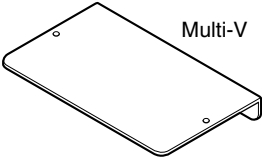
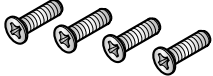
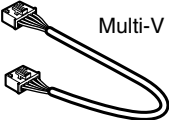
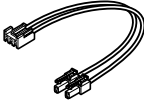
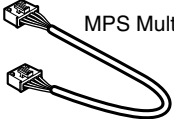
 <p>PI485 : PMNFP14A0(1EA) or PMNFP14A1(1EA) or PGNFP14A0(1EA)</p>	 <p>Multi-V</p> <p>BRACKET (1EA)</p>	 <p>SCREW (4EA)</p>
 <p>Multi-V</p> <p>WIRE ASSY 1(1EA)</p>	 <p>WIRE ASSY 2(1EA)</p>	 <p>MPS Multi</p> <p>WIRE ASSY 3(1EA)</p>

Others : Tie Wrap (3 EA) - Cable Tie
Clamp (1 EA)

Installation Guide

Installation Steps

1. **6** Connect CN_OUT with Outdoor Unit by the cable (provided)
2. **4 5** Connect RS-485 BUS_A(+) and BUS_(B)(-) with other network products (ex. Central Controller , I-Gateway.....)
3. **2 3** In case of using Simple Central Controller, connect VCC(+10V) and GND. No need to connect otherwise.
4. **8** Select DIP Switch Configuration(Refer page 8)
5. **1** Connect CN_PWR with Outdoor PCB Power connector (Refer page 9, 10)
6. After Power is ON, check the Communication LED **9**
 - LED1G(Red)
 - Normal : LED blinks for 5 times and then gets OFF
This process is repeated after every 3 minutes
 - Error : Check the Indoor Unit's address & wiring connections
 - LED2G(Yellow), LED3G(Orange)
 - Normal : LED blinks continuously
 - Error : Check the DIP Switch setting & wiring connections
7. **7** Check RS-485 Communication Status LED:
 - Normal : LED's blinks 2 times in every 10~30 seconds
 - Error : Check the wiring connections
8. Finally if all of the above steps are OK, then tie the cables by tie wraps & clamp



* Example about Multi V plus



CAUTION:



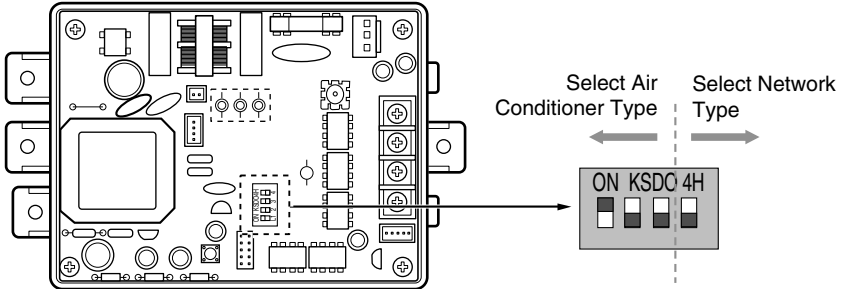

Install the PI485 on the Noise Filter in Multi V plus.
Install the PI485 after checking the hole for screw.

DIP Switch Configuration



* LGAP : LG Air conditioner Protocol

Multi V & Multi(LGAP applied) products Configuration Methods

-  → **1 ON, All others OFF:** Multi V products(Except CRUN products) or Multi(Non-Inverter) Product applied Common PCB(Refer to NOTE) or Multi(Inverter) Product + Central Controller(All types) - Without LGAP
-  → **1 and 4 ON, All others OFF:** Multi V products(Except CRUN products) or Multi(Non-Inverter) Product applied Common PCB or Multi(Inverter) Product + Central Controller(All types) - Using LGAP
-  → **2 ON, All others OFF:** Multi(Non-Inverter) Product + Centroller(All types) - Without LGAP
-  → **2 and 4 ON, All others OFF:** Multi Non-Inverter Product + Central Controller(All Types) - Using LGAP
-  → **1,2,3,4 ON :** Multi V CRUN Product + Central Controller(All types) - Using LGAP

* Please refer the corresponding Central Controller installation manual if you want to know whether your Central Controller is compatible with LGAP or not.



CAUTION:

**The wrong setting of air-conditioner switch could cause malfunctioning.
Switch setting must be done carefully.
Push the Reset button after changing the Dip switch.**

NOTE: Multi(Non-Inverter) Product applied Common PCB
PCB P/NO. : 6871A20917*
P/NO. : 6871A20918*
P/NO. : 6871A20910*

Simple Central Controller - Connection Diagram

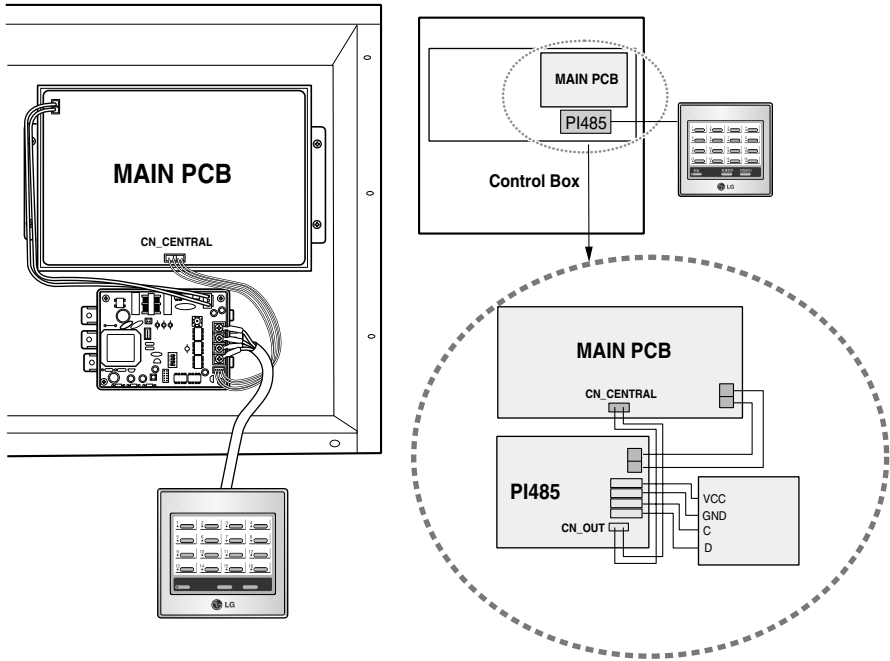

CAUTION:

After product installation, tie the cables with Clamps & Tie-Wraps provided. Check the right connection of each BUS A and BUS B.

PC/ Deluxe Central Controller - Connection Diagram

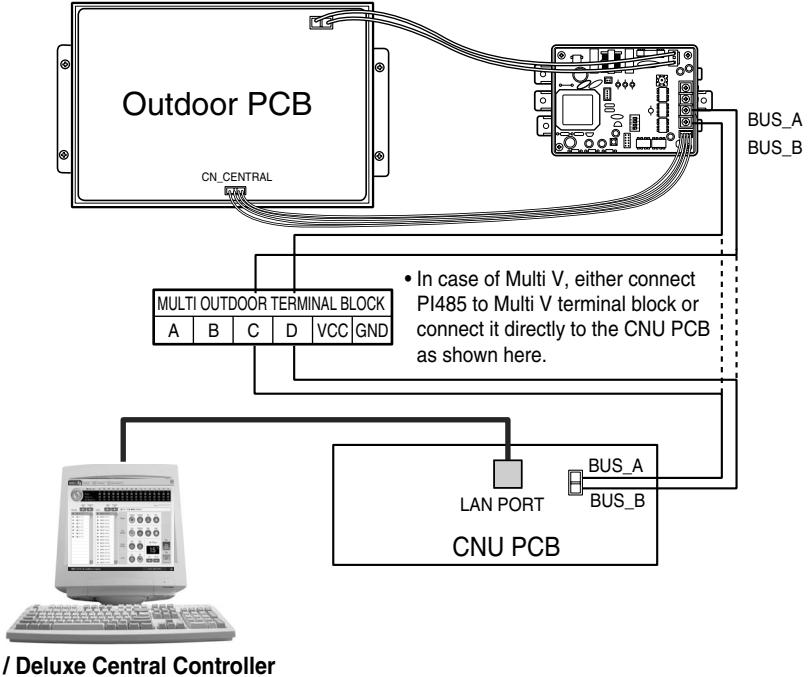

CAUTION:
After product installation, tie the cables with Clamps & Tie-Wraps provided.
Check the right connection of each BUS A and BUS B.

How to connect the base station controller

• PGNFP14A0 (Only)

Connecting the PI 485 communication line

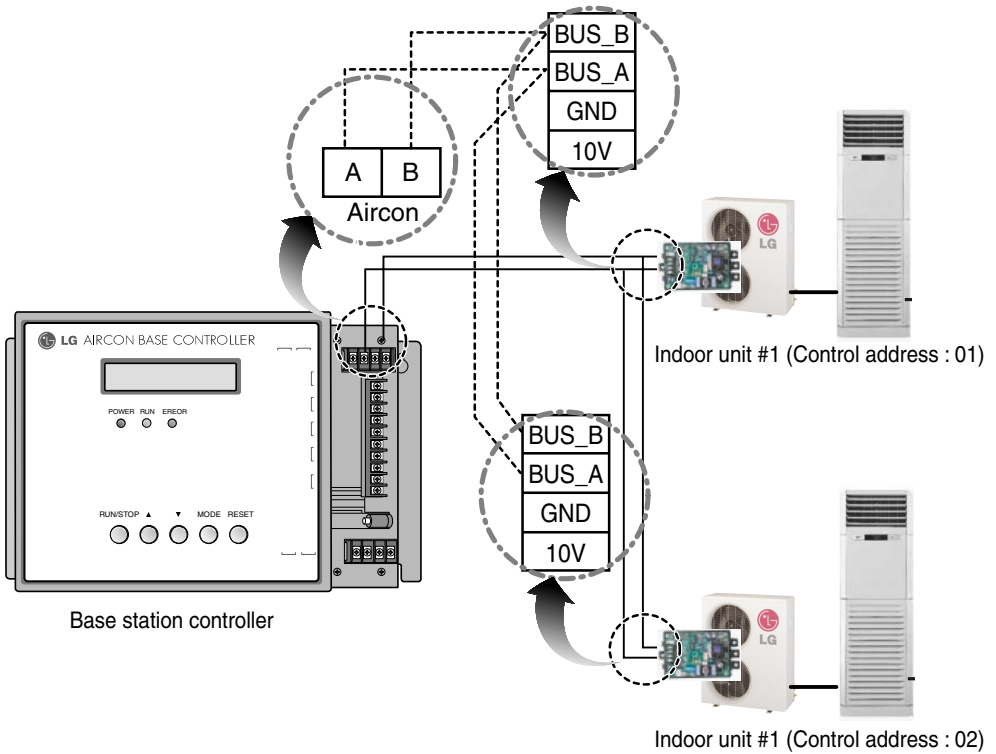

[Steps to connect]

***Note:** See the PI 485 manual for the internal setting.

***Note:** Because the RS485 communication line connecting to the PI 485 has polarity, check A and B. PI485

